

bien

www.bienexport.com

biQslab
MAXTON

2025

CATALOGUE

X

COL- LEC- TION

MERMER / MARBLE

05 AMANI BRONZE	55 MYSTIC GOLD
09 BELVEDERE	57 NOIR BLANC
11 BLACK CALACATTA	61 ORDESA
15 BLACK CALACATTA BOOKMATCH	63 PARADISO
17 CALACATTA BORGHINI	67 PIETRA GREY
21 CALACATTA CLASSIC	71 PORT LAURENT
23 CALACATTA MIELE	75 PORT LAURENT BOOKMATCH
27 CALACATTA ORO	77 RAIN GREY
31 CALACATTA ORO BOOKMATCH	79 SAHARA NOIR
33 CLAIR GREY	83 SILVER CLOUD
35 ELEGANT BLACK	87 SILVER ROOT
37 GREYLAC	91 SILVER ROOT BOOKMATCH
39 GREYLAC BOOKMATCH	93 STATUARIO
41 LUSH	97 STATUARIO LUXE
45 LUSTRE	101 TAJ MAHAL
49 MARRON GLACE	105 TUNDRA GREY
53 MARRON GLACE BOOKMATCH	109 VORTEX

TAŞ & BETON / STONE & CONCRETE

111 ARGENTO	131 EGEO
115 CHESTER	135 LITAI
117 TRAVERTEN WHITE	137 MORA
121 TRAVERTEN BEIGE	139 RAV
123 CORTEN	143 ROCCIA DESERTO
127 COSMO	145 SILVER MOON

AHŞAP / WOOD

149 EBONY

160X320 CM | 12MM

AMANI BRONZE

80X320 CM | 12MM



A

B



POLISHED

MARBLE LOOK

AMANI BRONZE

160X320 CM | 12MM
80X320 CM | 12MM



POLISHED

160X320 CM | 12MM

BELVEDERE

80X320 CM | 12MM



A

B



MAXSHINE

160X320 CM | 12MM

BLACK CALACATTA

80X320 CM | 12MM

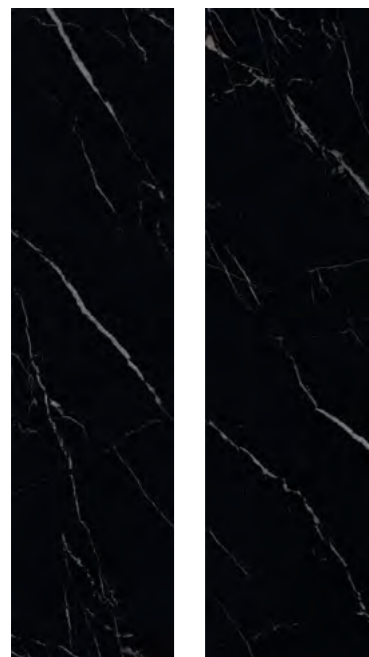

A

B



POLISHED

MARBLE LOOK

BLACK CALACATTA

160X320 CM | 12MM
80X320 CM | 12MM



POLISHED

BLACK CALACATTA BOOKMATCH

160X320 CM | 12MM

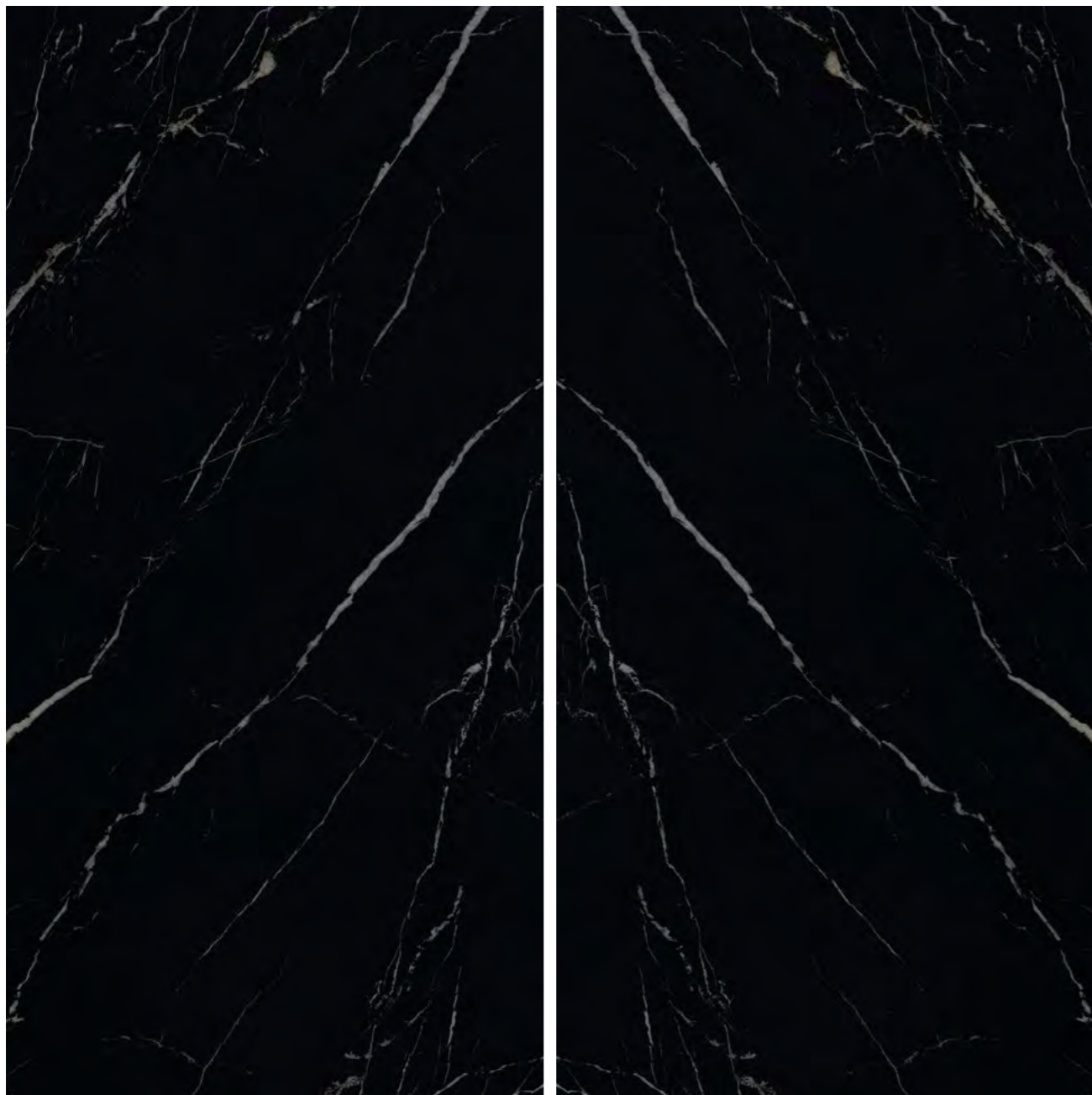

POLISHED

160X320 CM | 12MM

CALACATTA BORGHINI

80X320 CM | 12MM

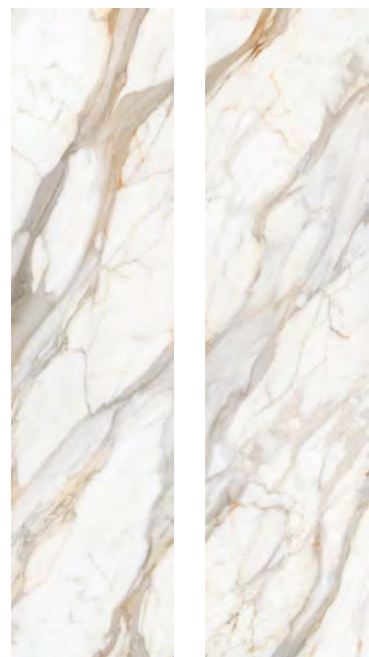

A

B



POLISHED
SATEN

MARBLE LOOK

CALACATTA BORGHINI

160X320 CM | 12MM
80X320 CM | 12MM



POLISHED
SATEN

160X320 CM | 12MM



CALACATTA CLASSIC

80X320 CM | 12MM



A

B



POLISHED
MATT

160X320 CM | 12MM



CALACATTA MIELE

80X320 CM | 12MM



A

B



POLISHED
SATEN

MARBLE LOOK

CALACATTA MIELE

160X320 CM | 12MM
80X320 CM | 12MM



POLISHED
SATEN

160X320 CM | 12MM



CALACATTA ORO

80X320 CM | 12MM



A

B



POLISHED
SATEN

MARBLE LOOK

CALACATTA ORO

160X320 CM | 12MM
80X320 CM | 12MM



POLISHED
SATEN

CALACATTA ORO BOOKMATCH

160X320 CM | 12MM



POLISHED

160X320 CM | 12MM

CLAIR GREY

80X320 CM | 12MM



A

B



POLISHED

160X320 CM | 12MM

ELEGANT BLACK

80X320 CM | 12MM



A

B



POLISHED

160X320 CM | 12MM



GREYLAC

80X320 CM | 12MM



A

B



POLISHED

GREYLAC BOOKMATCH

160X320 CM | 12MM



POLISHED

160X320 CM | 12MM

LUSH

80X320 CM | 12MM



A



B



POLISHED
SATEN

MARBLE LOOK

LUSH

160X320 CM | 12MM
80X320 CM | 12MM

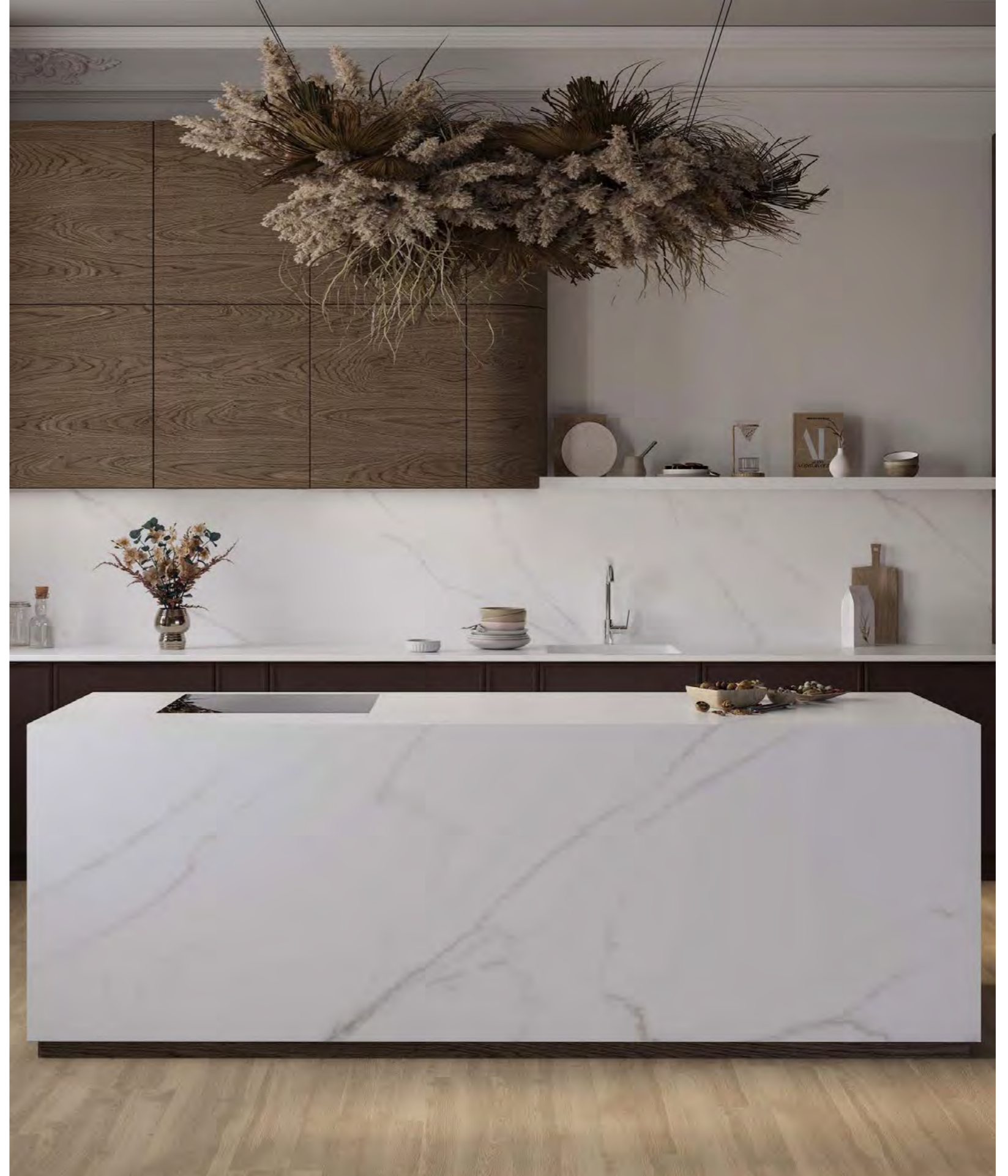

POLISHED
SATEN

160X320 CM | 12MM

LUSTRE

80X320 CM | 12MM



A

B



POLISHED

MARBLE LOOK

LUSTRE

160X320 CM | 12MM
80X320 CM | 12MM



POLISHED

160X320 CM | 12MM

MARRON GLACE

80X320 CM | 12MM

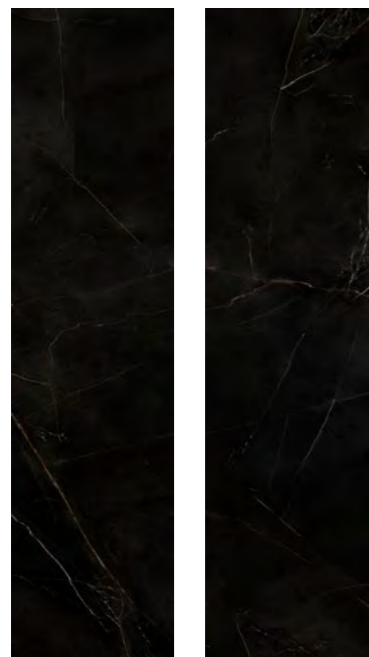

A

B



POLISHED

MARBLE LOOK

MARRON GLACE

160X320 CM | 12MM
80X320 CM | 12MM



POLISHED

MARRON GLACE BOOKMATCH

160X320 CM | 12MM



POLISHED

160X320 CM | 12MM

MYSTIC GOLD

80X320 CM | 12MM



A

B



POLISHED

160X320 CM | 12MM

NOIR BLANC

80X320 CM | 12MM



A

B



POLISHED
MATT

MARBLE LOOK

NOIR BLANC

160X320 CM | 12MM
80X320 CM | 12MM



POLISHED
MATT

160X320 CM | 12MM

ORDESA

80X320 CM | 12MM



A

B



MAXSHINE

160X320 CM | 12MM

PARADISO

80X320 CM | 12MM



A

B

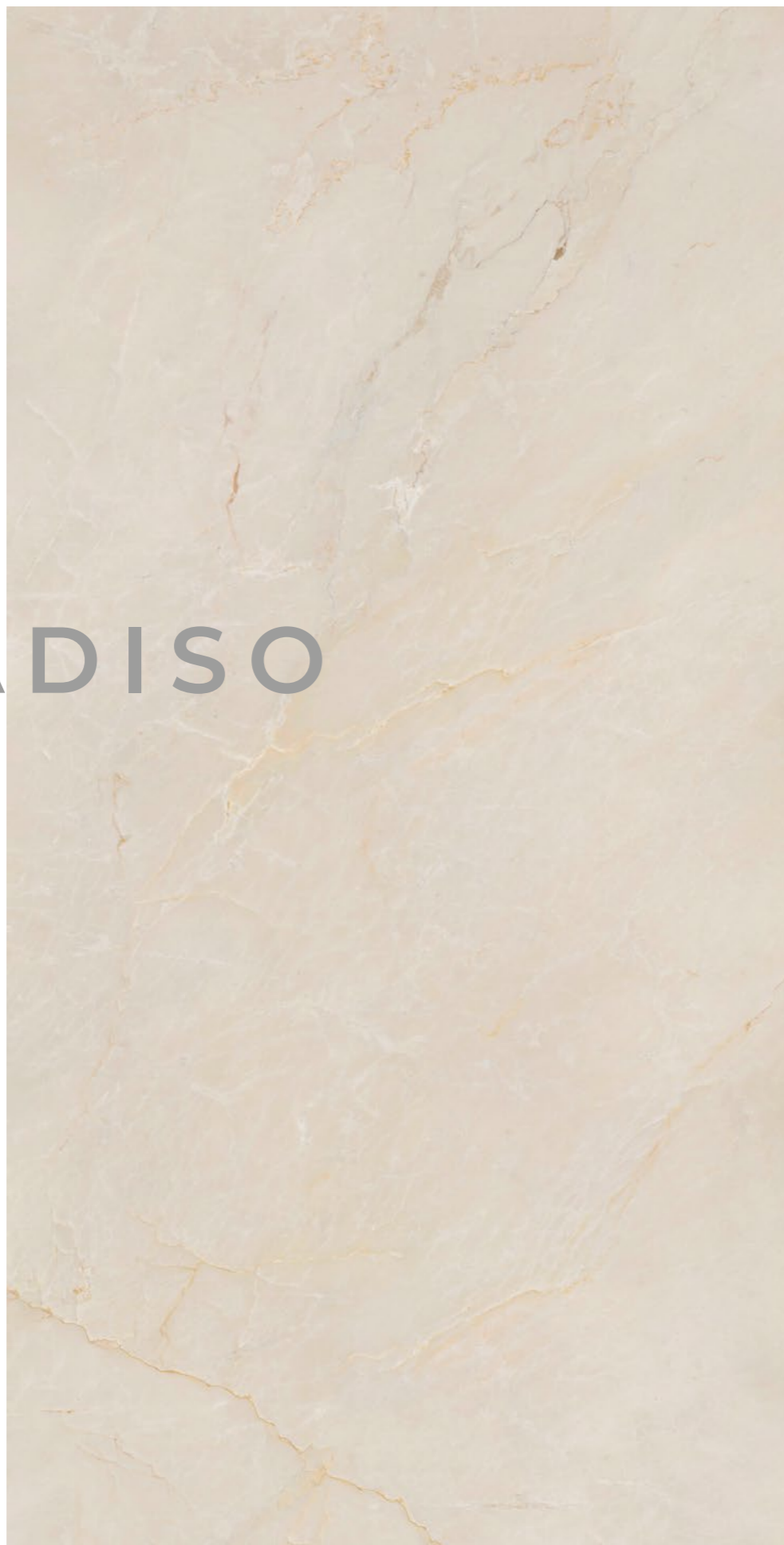

POLISHED
MATT

MARBLE LOOK

PARADISO

160X320 CM | 12MM
80X320 CM | 12MM



POLISHED
MATT

160X320 CM | 12MM

PIETRA GREY

80X320 CM | 12MM



A

B



POLISHED
MATT

MARBLE LOOK

PIETRA GREY

160X320 CM | 12MM
80X320 CM | 12MM



POLISHED
MATT

160X320 CM | 12MM

PORT LAURENT

80X320 CM | 12MM

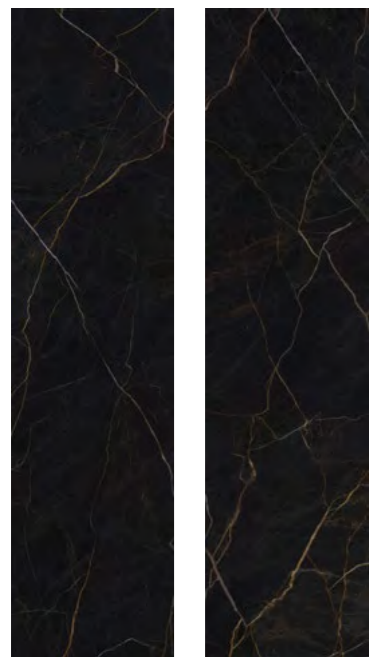

A

B



POLISHED

MARBLE LOOK

PORT LAURENT

160X320 CM | 12MM
80X320 CM | 12MM



POLISHED

PORT LAURENT BOOKMATCH

160X320 CM | 12MM

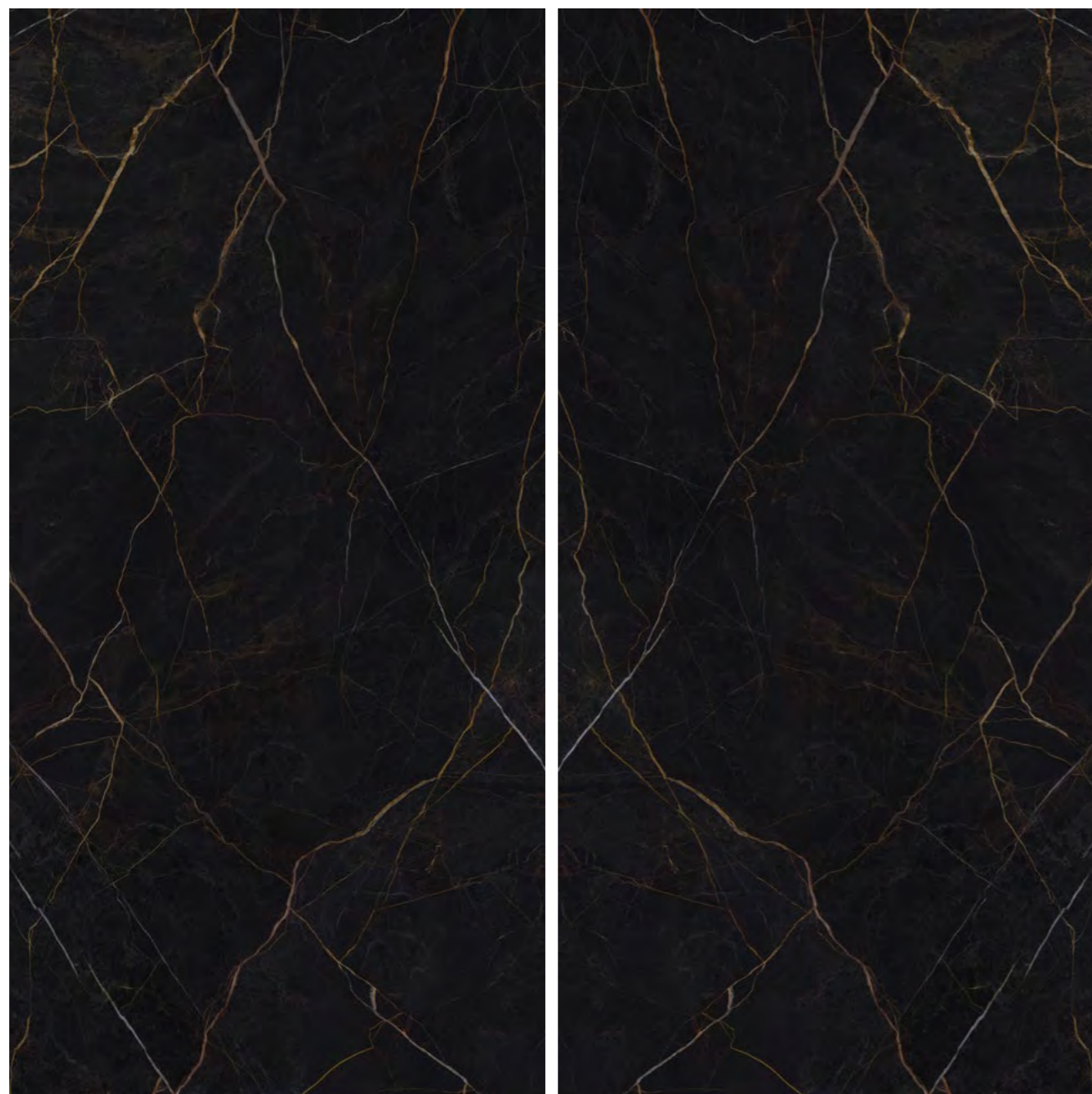

POLISHED

160X320 CM | 12MM

RAIN GREY

80X320 CM | 12MM

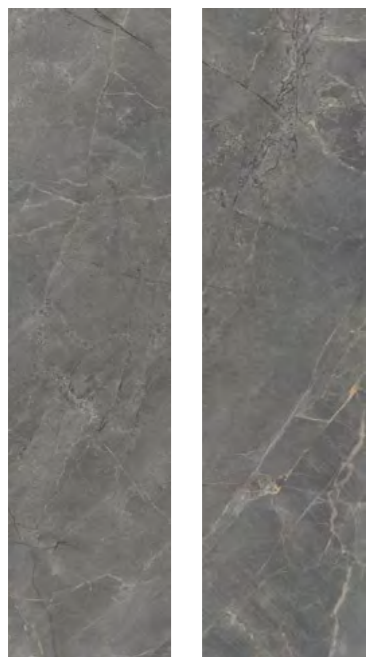

A

B

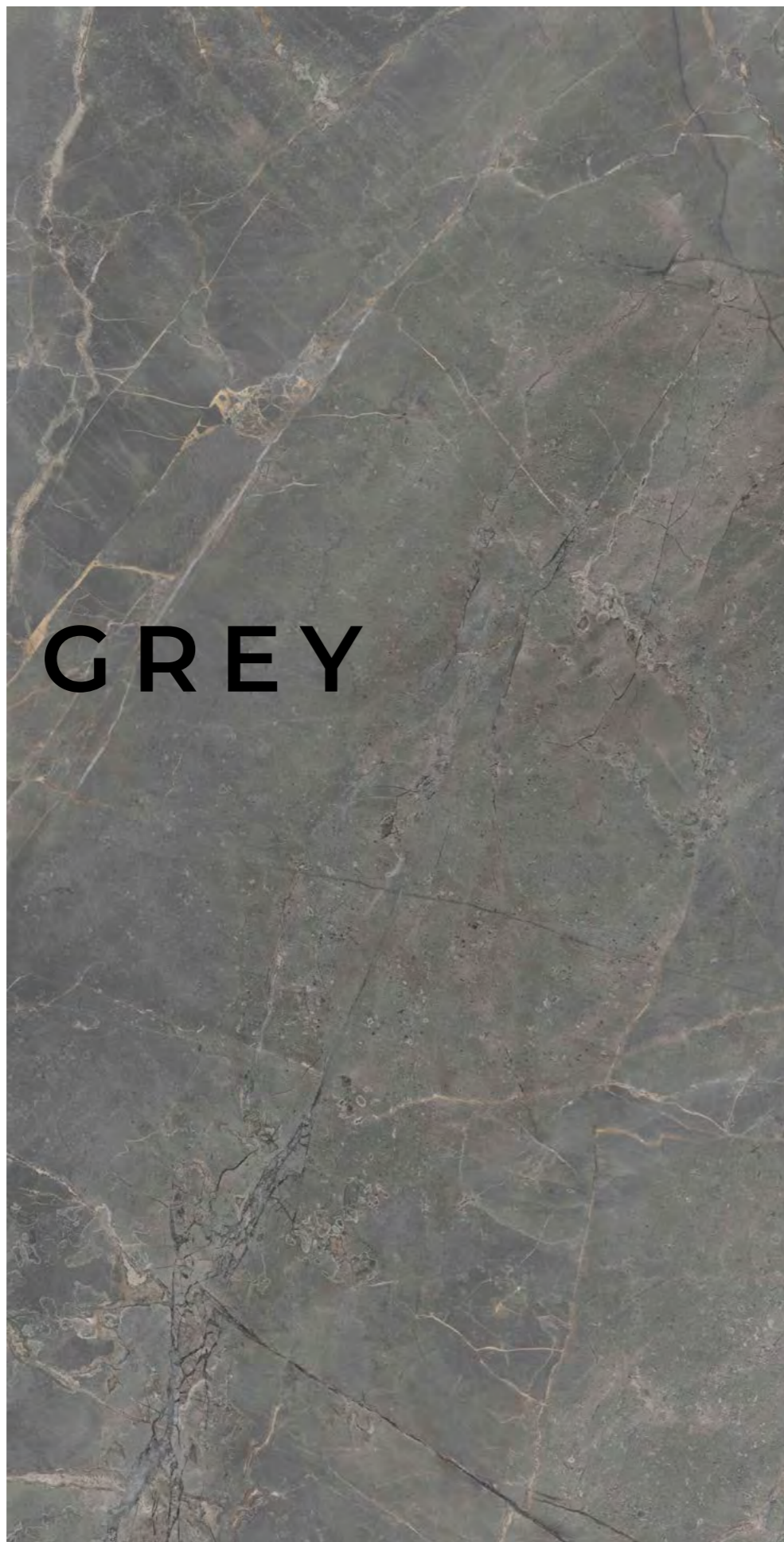

NATURALE MATT

160X320 CM | 12MM

SAHARA NOIR

80X320 CM | 12MM

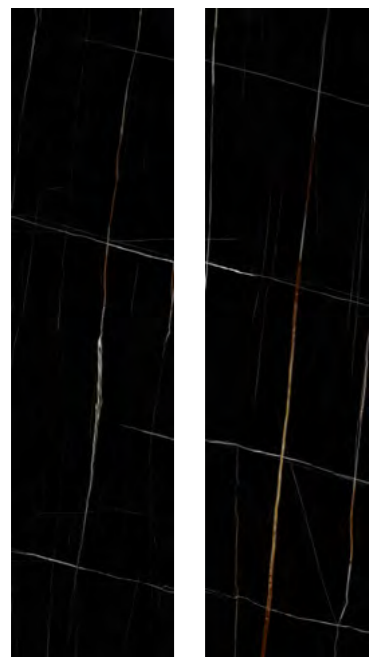

A

B



POLISHED

MARBLE LOOK

SAHARA NOIR

160X320 CM | 12MM
80X320 CM | 12MM



POLISHED

160X320 CM | 12MM



SILVER CLOUD

80X320 CM | 12MM



A

B



POLISHED
MATT

MARBLE LOOK

SILVER CLOUD

160X320 CM | 12MM
80X320 CM | 12MM



POLISHED
MATT

160X320 CM | 12MM

SILVER ROOT

80X320 CM | 12MM



A

B



POLISHED

MARBLE LOOK

SILVER ROOT

160X320 CM | 12MM
80X320 CM | 12MM



POLISHED

SILVER ROOT BOOKMATCH

160X320 CM | 12MM



POLISHED

160X320 CM | 12MM



STATUARIO

80X320 CM | 12MM



A

B



POLISHED

MARBLE LOOK

STATUARIO

160X320 CM | 12MM
80X320 CM | 12MM



POLISHED

160X320 CM | 12MM



STATUARIO LUXE

80X320 CM | 12MM

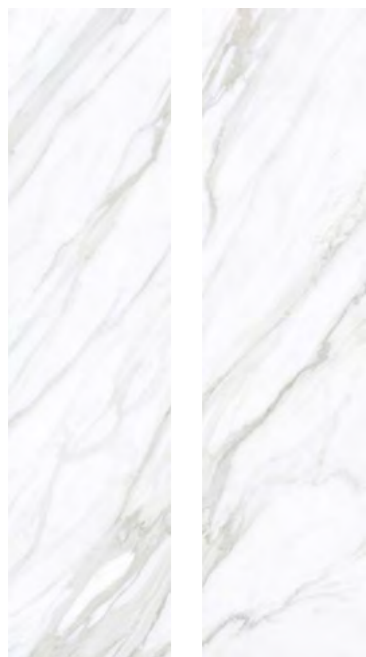

A

B



POLISHED
SATEN

MARBLE LOOK

STATUARIO LUXE

160X320 CM | 12MM
80X320 CM | 12MM



POLISHED
SATEN

160X320 CM | 12MM



TAJ MAHAL

80X320 CM | 12MM



A

B



POLISHED
SATEN

MARBLE LOOK

TAJ MAHAL

160X320 CM | 12MM
80X320 CM | 12MM



POLISHED
SATEN

160X320 CM | 12MM

TUNDRA GREY

80X320 CM | 12MM



A

B



POLISHED
NATURALE MATT

MARBLE LOOK

TUNDRA GREY

160X320 CM | 12MM
80X320 CM | 12MM



POLISHED
NATURALE MATT

160X320 CM | 12MM



VORTEX

80X320 CM | 12MM

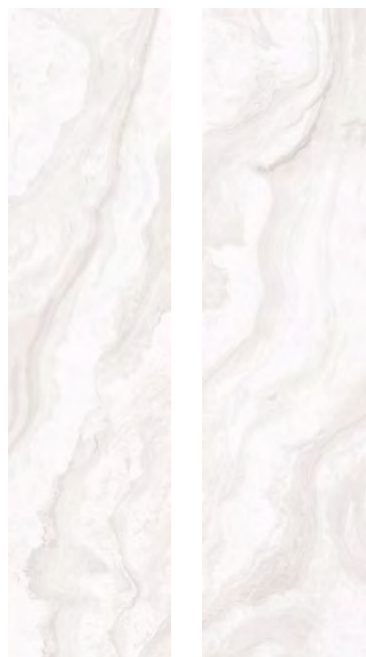

A

B

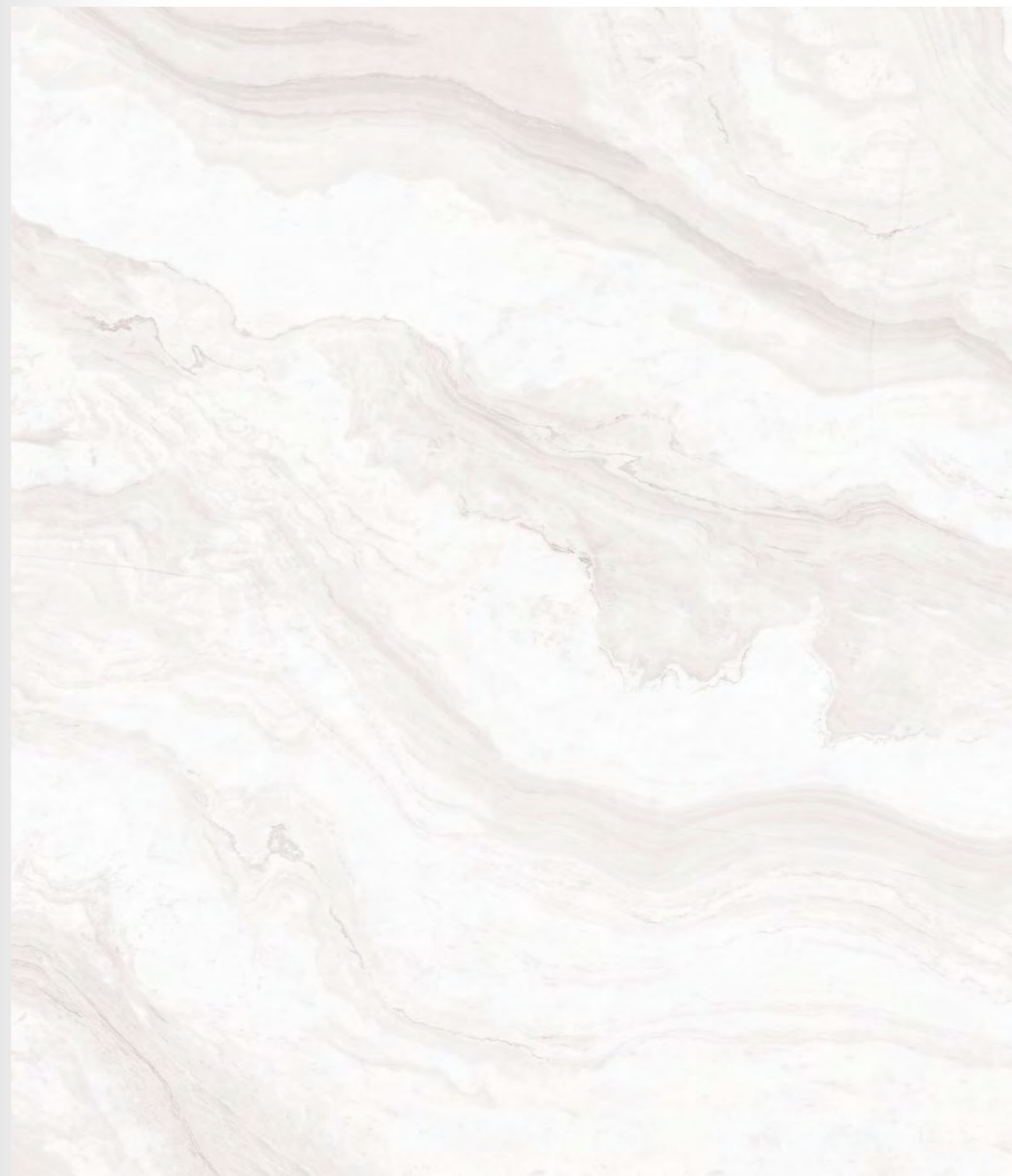

POLISHED

160X320 CM | 12MM

ARGENTO

80X320 CM | 12MM

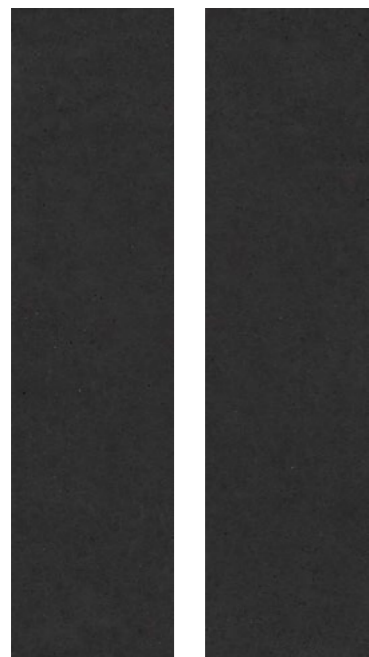

A

B



NATURALE MATT

STONE LOOK

ARGENTO

160X320 CM | 12MM
80X320 CM | 12MM



NATURALE MATT

160X320 CM | 12MM

CHESTER

80X320 CM | 12MM

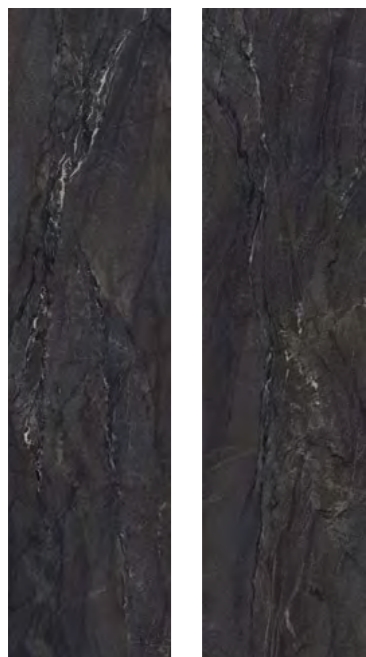

A

B



NATURALE MATT

160X320 CM | 12MM

TRAVERTEN WHITE

80X320 CM | 12MM



A

B



NATURALE MATT

STONE LOOK

TRAVERTEN WHITE

160X320 CM | 12MM
80X320 CM | 12MM



NATURALE MATT

160X320 CM | 12MM



TRAVERTEN BEIGE

80X320 CM | 12MM



A

B



NATURALE MATT

160X320 CM | 12MM

CORTEN

80X320 CM | 12MM



A

B



NATURALE MATT

STONE LOOK

CORTEN

160X320 CM | 12MM
80X320 CM | 12MM



NATURALE MATT

160X320 CM | 12MM



COSMO

80X320 CM | 12MM



A

B



NATURALE MATT

STONE LOOK

COSMO

160X320 CM | 12MM
80X320 CM | 12MM



NATURALE MATT

160X320 CM | 12MM

EGEO

80X320 CM | 12MM

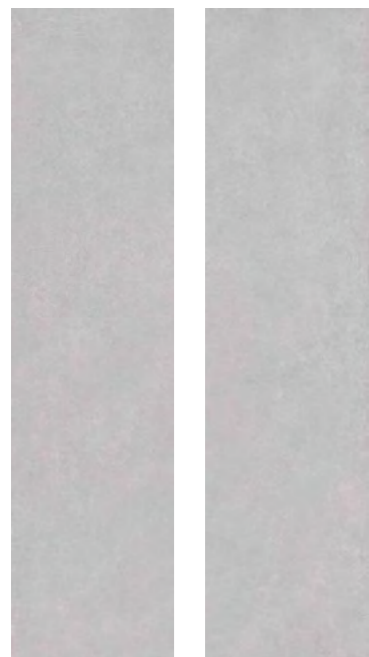

A

B

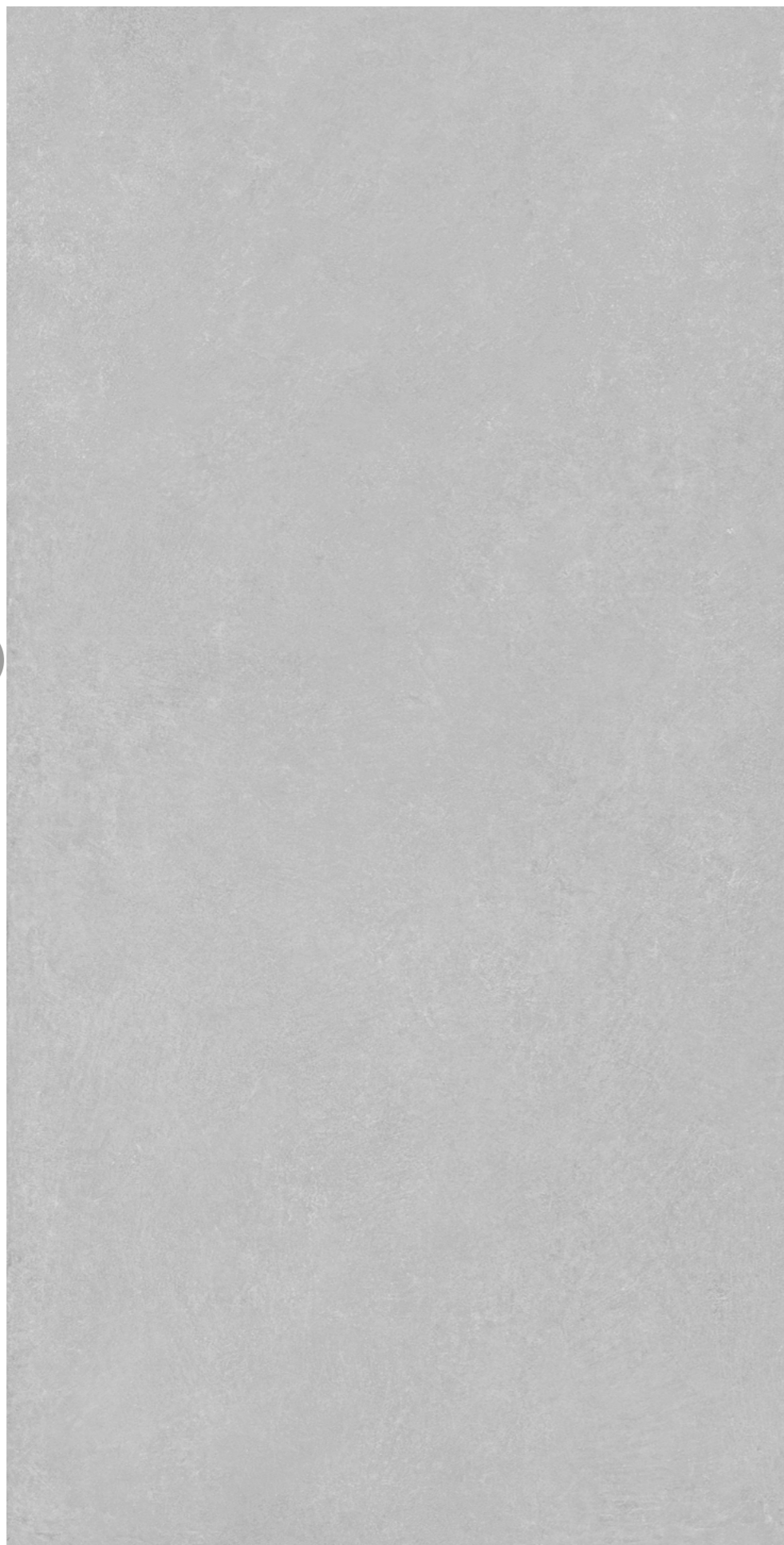

MATT

CONCRETE LOOK

EGEO

160X320 CM | 12MM
80X320 CM | 12MM



MATT

160X320 CM | 12MM



LITAI

80X320 CM | 12MM



A

B



MATT

160X320 CM | 12MM



MORA

80X320 CM | 12MM

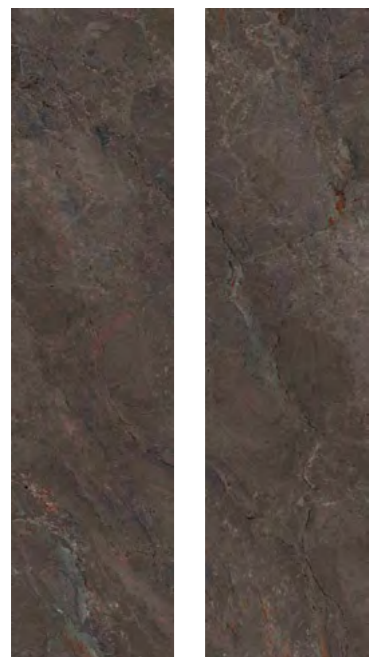

A

B



NATURALE MATT

160X320 CM | 12MM

RAV

80X320 CM | 12MM



A

B



NATURALE MATT

STONE LOOK

RAV

160X320 CM | 12MM
80X320 CM | 12MM



NATURALE MATT

160X320 CM | 12MM

ROCCIA DESERTO

80X320 CM | 12MM



A

B



NATURALE MATT

160X320 CM | 12MM

SILVER MOON

80X320 CM | 12MM



A

B



POLISHED
NATURALE MATT

STONE LOOK

SILVER MOON

160X320 CM | 12MM
80X320 CM | 12MM



POLISHED
NATURALE MATT

160X320 CM | 12MM

EBONY

80X320 CM | 12MM



A

B



NATURALE MATT

WOOD LOOK

EBONY

160X320 CM | 12MM
80X320 CM | 12MM





NATURALE MATT

X

TECH-
NICAL

DET-
AILS

bien		SIRLI PORSELEN SERAMİKLERİ TEKNİK ÖZELLİKLERİ 162*323*12 FULL POLİŞH/ NO REC. TECHNICAL SPECIFICATIONS OF GLAZED PORCELAIN CERAMIC 160*320 FULL POLISH	
Standartlar	Teknik Özellikler Technical Characteristics	BİEN Seramik Sırlı Ürün Test Değerleri ^ BİEN Seramik Glazed Product Declared Values^	
EN ISO 10545-2	Boyut ve Yüzey Kalitesi Dimensions and surface quality	Uzunluk ve genişlik Length and width	± %0.4
		Kalınlık Thickness	± % 0.5 (± % 0.5 mm)
		Kenar düzgünlüğü Edge smoothness	± % 0.3
		Gönyeden Sapma Miter deviation	± % 0.3
		Merkez-Kenar Eğriliği Pençlik Centre-edge curvature-warpage	± 0.2 /-0.1
	Yüzey Kalitesi Surface quality	%95	
EN ISO 10545-3	Su Emme % Water Absorption %	≤ % 0.3	
EN ISO 10545-4	Kırılma dayanımı (N) Breking strenght (N)	Kalınlık≥7.50mm Thickness≥7.50mm	12 mm ≥ 3500 N 20mm ≥ 10000 N
		Kalınlık<7.50mm Thickness<7.50mm	min. 750 N
	Eğilme dayanımı (N/ mm ²) Modulus of rupture (N/ mm ²)	6 mm ≥ 35 N /mm ² 12mm ≥ 40 N / mm ² 20mm ≥ 45 N / mm ²	
EN ISO 10545-5	Sıçrama katsayısı çarpma dayanımı Impact resistance as coefficient of restitution (cor)	Dayanıklıldır Resistant	
EN ISO 10545-7	Aşınma Dayanımı Abrasion Resistance	Sınıf 2-3-4 Class 2-3-4	
EN ISO 10545-8	Doğrusal ısı genleşme katsayısı(100 ° C) Linear thermal expansion	6.00 x10 ⁻⁶ -7.50 x10 ⁻⁶	
EN ISO 10545-9	Isıl Şoka dayanıklılık Thermal shock resistance	Dayanıklıldır Resistant	
EN ISO 10545-10	Nem genleşmesi Moisture expansion	% 0.01	
EN ISO 10545-11	Çatlama Dayanımı Crazing resistance	Dayanıklıldır Resistant	
EN ISO 10545-12	Dona Dayanım Frost resitance	Dayanıklıldır Resistant	
EN ISO 10545-13	Düşük derişimli asit ve baz Resistance to low concentrations of acids and alkalis	LA LA	
	Yüksek derişimli asit ve baz Resistance to high concentrations of acids and alkalis	HB HB	
	Ev kimyasalları ve yüzme havuzu tuzları Resistance to household chemicals and swimming pool salts	A A	
EN ISO 10545-14	Lekelenmeye dayanıklılık Resistance to staining	min.3.sınıf min.3.class	
EN ISO 10545-15	Açığa çıkan tehlikeli maddeler / Kurşun- Kadmiyum Release of dangerous substance Lead- Cadmium	Pb < 0.1 Cd < 0.01	
DIN 51130 -51097 CEN/ TS 16165	Kayganlık (Ramp Tayini) Slipperiness	•	
EN 12004:2007 +A1:2012.4.1	Yapışma için bağ gücü Bond strenght adhesion	Çimentolu Yapıştırıcılar Cementitious adhesives	≥ 1,0 Tip C2
EN 12004:2007 +A1:2012.4.2		Dağılım Yapıştırıcılar Dispersion adhesives	•
12004-2007+A1 2012.4.3		Reçine reaksiyonlu yapıştırıcılar Reaction resin adhesives	•
		Harç Mortar	•
DIN 51094	Duvar ve zemin seramik karolarının ışık haslığı ve renk haslığı, renk değışimi Light fastness and color fastness of wall and floor ceramic tiles, color change	Değışmez	
EN13823 EN9239-1	Yangına tepki Reaction to fire	A1 or A1 s	
CEN / TS15209	Dokunurluk Tactility	Yüzey açıklaması beyan edilir Declare surface description	
	SHADE VARIATIONS V1- V5 DESEN,YÜZ FARKLILİĞİ		Ürüne Özel Bildirilir Product Specific Notifications

bien		SIRLI PORSELEN SERAMİKLERİ TEKNİK ÖZELLİKLERİ 162*323*12 MAT/SATEN /NO REC. TECHNICAL SPECIFICATIONS OF GLAZED PORCELAIN CERAMIC 160*320*12 MAT/SATEN	
Standartlar	Teknik Özellikler Technical Characteristics	BİEN Seramik Sırlı Ürün Test Değerleri ^ BİEN Seramik Glazed Product Declared Values^	
EN ISO 10545-2	Boyut ve Yüzey Kalitesi Dimensions and surface quality	Uzunluk ve genişlik Length and width	± %0.4
		Kalınlık Thickness	± % 0.5 (± % 0.5 mm)
		Kenar düzgünlüğü Edge smoothness	± % 0.3
		Gönyeden Sapma Miter deviation	± % 0.3
		Merkez-Kenar Eğriliği Pençlik Centre-edge curvature-warpage	± 0.2 /-0.1
	Yüzey Kalitesi Surface quality	%95	
EN ISO 10545-3	Su Emme % Water Absorption %	≤ % 0.3	
EN ISO 10545-4	Kırılma dayanımı (N) Breking strenght (N)	Kalınlık≥7.50mm Thickness≥7.50mm	12 mm ≥ 3500 N 20mm ≥ 10000 N
		Kalınlık<7.50mm Thickness<7.50mm	min. 750 N
	Eğilme dayanımı (N/ mm ²) Modulus of rupture (N/ mm ²)	6 mm ≥ 35 N /mm ² 12mm ≥ 40 N / mm ² 20mm ≥ 45 N / mm ²	
EN ISO 10545-5	Sıçrama katsayısı çarpma dayanımı Impact resistance as coefficient of restitution (cor)	Dayanıklıldır Resistant	
EN ISO 10545-7	Aşınma Dayanımı Abrasion Resistance	Sınıf 2-3-4 Class 2-3-4	
EN ISO 10545-8	Doğrusal ısı genleşme katsayısı(100 ° C) Linear thermal expansion	6.00 x10 ⁻⁶ -7.50 x10 ⁻⁶	
EN ISO 10545-9	Isıl Şoka dayanıklılık Thermal shock resistance	Dayanıklıldır Resistant	
EN ISO 10545-10	Nem genleşmesi Moisture expansion	% 0.01	
EN ISO 10545-11	Çatlama Dayanımı Crazing resistance	Dayanıklıldır Resistant	
EN ISO 10545-12	Dona Dayanım Frost resitance	Dayanıklıldır Resistant	
EN ISO 10545-13	Düşük derişimli asit ve baz Resistance to low concentrations of acids and alkalis	LA LA	
	Yüksek derişimli asit ve baz Resistance to high concentrations of acids and alkalis	HA HA	
	Ev kimyasalları ve yüzme havuzu tuzları Resistance to household chemicals and swimming pool salts	A A	
EN ISO 10545-14	Lekelenmeye dayanıklılık Resistance to staining	min.3.sınıf min.3.class	
EN ISO 10545-15	Açığa çıkan tehlikeli maddeler / Kurşun- Kadmiyum Release of dangerous substance Lead- Cadmium	Pb < 0.1 Cd < 0.01	
DIN 51130 -51097 CEN/ TS 16165	Kayganlık (Ramp Tayini) Slipperiness	•	
EN 12004-2007+A1 2012.4.1	Yapışma için bağ gücü Bond strenght adhesion	Çimentolu Yapıştırıcılar Cementitious adhesives	≥ 1,0 Tip C2
EN 12004-2007+A1 2012.4.2		Dağılım Yapıştırıcılar Dispersion adhesives	•
12004-2007+A1 2012.4.3		Reçine reaksiyonlu yapıştırıcılar Reaction resin adhesives	•
		Harç Mortar	•
DIN 51094	Duvar ve zemin seramik karolarının ışık haslığı ve renk haslığı, renk değışimi Light fastness and color fastness of wall and floor ceramic tiles, color change	Değışmez	
EN13823 EN9239-1	Yangına tepki Reaction to fire	A1 or A1 s	
CEN / TS15209	Dokunurluk Tactility	Yüzey açıklaması beyan edilir Declare surface description	
	SHADE VARIATIONS V1- V5 DESEN,YÜZ FARKLILİĞİ		Ürüne Özel Bildirilir Product Specific Notifications

bien		SIRLI PORSELEN SERAMİKLERİ TEKNİK ÖZELLİKLERİ 80*320*12 FULL POLISH TECHNICAL SPECIFICATIONS OF GLAZED PORCELAIN CERAMIC 80*320 FULL POLISH	
Standartlar	Teknik Özellikler Technical Characteristics	BİEN Seramik Sırlı Ürün Test Değerleri [^] BİEN Seramik Glazed Product Declared Values [^]	
EN ISO 10545-2	Boyut ve Yüzey Kalitesi Dimensions and surface quality	Uzunluk ve genişlik Length and width	± %0,4
		Kalınlık Thickness	± % 0,5 (± % 0,5 mm)
		Kenar düzgünlüğü Edge smoothness	± % 0,3
		Gönyeden Sapma Miter deviation	± 0,3
		Merkez-Kenar Eğriliği Pençlik Centre-edge curvature-warpage	± 0,2 /-0,1
	Yüzey Kalitesi Surface quality	%95	
EN ISO 10545-3	Su Emme % Water Absorption %	≤ % 0,3	
EN ISO 10545-4	Kırılma dayanımı (N) Breking strenght (N)	Kalınlık≥7,50mm Thickness≥7,50mm	12 mm ≥ 3500 N 20mm ≥ 10000 N
		Kalınlık<7,50mm Thickness<7,50mm	min. 750 N
	Eğilme dayanımı (N/ mm ²) Modulus of rupture (N/ mm ²)	6 mm ≥ 35 N /mm ² 12mm ≥ 40 N / mm ² 20mm ≥ 45 N / mm ²	
EN ISO 10545-5	Sıçrama katsayısı çarpma dayanımı Impact resistance as coefficient of restitution (cor)	Dayanıklıldır Resistant	
EN ISO 10545-7	Aşınma Dayanımı Abrasion Resistance	Sınıf 2-3-4 Class 2-3-4	
EN ISO 10545-8	Doğrusal ısı genleşme katsayısı(100 ° C) Linear thermal expansion	6,00 x10 ⁻⁶ -7,50 x10 ⁻⁶	
EN ISO 10545-9	Isıl Şoka dayanıklılık Thermal shock resistance	Dayanıklıldır Resistant	
EN ISO 10545-10	Nem genleşmesi Moisture expansion	% 0,01	
EN ISO 10545-11	Çatlama Dayanımı Crazing resistance	Dayanıklıldır Resistant	
EN ISO 10545-12	Dona Dayanım Frost resitance	Dayanıklıldır Resistant	
EN ISO 10545-13	Düşük derişimli asit ve baz Resistance to low concentrations of acids and alkalis	LA LA	
	Yüksek derişimli asit ve baz Resistance to high concentrations of acids and alkalis	HB HB	
	Ev kimyasalları ve yüzme havuzu tuzları Resistance to household chemicals and swimming pool salts	A A	
EN ISO 10545-14	Lekelenmeye dayanıklılık Resistance to staining	min.3.sınıf min.3.class	
EN ISO 10545-15	Açığa çıkan tehlikeli maddeler / Kurşun- Kadmiyum Release of dangerous substance Lead- Cadmium	Pb < 0,1 Cd < 0,01	
DIN 51130 -51097 CEN/ TS 16165	Kayganlık (Ramp Tayini) Slipperiness	Sınıf R9-R10-R11-R-12 Class R9-R10-R11-R-12	
EN 12004:2007 +A1:2012.4.1	Yapışma için bağ gücü Bond strenght adhesion	Çimentolu Yapıştırıcılar Cementitious adhesives	≥ 1,0 Tip C2
EN 12004:2007 +A1:2012.4.2		Dağılım Yapıştırıcılar Dispersion adhesives	*
12004-2007+A1 2012.4.3		Reçine reaksiyonlu yapıştırıcılar Reaction resin adhesives	*
		Harç Mortar	*
DIN 51094	Duvar ve zemin seramik karolarının ışık haslığı ve renk haslığı, renk değışimi Light fastness and color fastness of wall and floor ceramic tiles, color change	Değışmez	
EN13823 EN9239-1	Yangına tepki Reaction to fire	A1 or A1 s	
CEN / TS15209	Dokunurluk Tactility	Yüzey açıklaması beyan edilir Declare surface description	
	SHADE VARIATIONS V1- V5 DESEN,YÜZ FARKLİLİĞİ		Ürüne Özel Bildirilir Product Specific Notifications

bien		SIRLI PORSELEN SERAMİKLERİ TEKNİK ÖZELLİKLERİ 80*320*12 MAT/SATEN TECHNICAL SPECIFICATIONS OF GLAZED PORCELAIN CERAMIC 160*320*12 MAT/SATEN	
Standartlar	Teknik Özellikler Technical Characteristics	BİEN Seramik Sırlı Ürün Test Değerleri [^] BİEN Seramik Glazed Product Declared Values [^]	
EN ISO 10545-2	Boyut ve Yüzey Kalitesi Dimensions and surface quality	Uzunluk ve genişlik Length and width	± %0,4
		Kalınlık Thickness	± % 0,5 (± % 0,5 mm)
		Kenar düzgünlüğü Edge smoothness	± % 0,3
		Gönyeden Sapma Miter deviation	± 0,3
		Merkez-Kenar Eğriliği Pençlik Centre-edge curvature-warpage	± 0,2 /-0,1
	Yüzey Kalitesi Surface quality	%95	
EN ISO 10545-3	Su Emme % Water Absorption %	≤ % 0,3	
EN ISO 10545-4	Kırılma dayanımı (N) Breking strenght (N)	Kalınlık≥7,50mm Thickness≥7,50mm	12 mm ≥ 3500 N 20mm ≥ 10000 N
		Kalınlık<7,50mm Thickness<7,50mm	min. 750 N
	Eğilme dayanımı (N/ mm ²) Modulus of rupture (N/ mm ²)	6 mm ≥ 35 N /mm ² 12mm ≥ 40 N / mm ² 20mm ≥ 45 N / mm ²	
EN ISO 10545-5	Sıçrama katsayısı çarpma dayanımı Impact resistance as coefficient of restitution (cor)	Dayanıklıldır Resistant	
EN ISO 10545-7	Aşınma Dayanımı Abrasion Resistance	Sınıf 2-3-4 Class 2-3-4	
EN ISO 10545-8	Doğrusal ısı genleşme katsayısı(100 ° C) Linear thermal expansion	6,00 x10 ⁻⁶ -7,50 x10 ⁻⁶	
EN ISO 10545-9	Isıl Şoka dayanıklılık Thermal shock resistance	Dayanıklıldır Resistant	
EN ISO 10545-10	Nem genleşmesi Moisture expansion	% 0,01	
EN ISO 10545-11	Çatlama Dayanımı Crazing resistance	Dayanıklıldır Resistant	
EN ISO 10545-12	Dona Dayanım Frost resitance	Dayanıklıldır Resistant	
EN ISO 10545-13	Düşük derişimli asit ve baz Resistance to low concentrations of acids and alkalis	LA LA	
	Yüksek derişimli asit ve baz Resistance to high concentrations of acids and alkalis	HA HA	
	Ev kimyasalları ve yüzme havuzu tuzları Resistance to household chemicals and swimming pool salts	A A	
EN ISO 10545-14	Lekelenmeye dayanıklılık Resistance to staining	min.3.sınıf min.3.class	
EN ISO 10545-15	Açığa çıkan tehlikeli maddeler / Kurşun- Kadmiyum Release of dangerous substance Lead- Cadmium	Pb < 0,1 Cd < 0,01	
DIN 51130 -51097 CEN/ TS 16165	Kayganlık (Ramp Tayini) Slipperiness	Sınıf R9-R10-R11-R-12 Class R9-R10-R11-R-12	
EN 12004-2007+A1 2012.4.1	Yapışma için bağ gücü Bond strenght adhesion	Çimentolu Yapıştırıcılar Cementitious adhesives	≥ 1,0 Tip C2
EN 12004-2007+A1 2012.4.2		Dağılım Yapıştırıcılar Dispersion adhesives	*
12004-2007+A1 2012.4.3		Reçine reaksiyonlu yapıştırıcılar Reaction resin adhesives	*
		Harç Mortar	*
DIN 51094	Duvar ve zemin seramik karolarının ışık haslığı ve renk haslığı, renk değışimi Light fastness and color fastness of wall and floor ceramic tiles, color change	Değışmez	
EN13823 EN9239-1	Yangına tepki Reaction to fire	A1 or A1 s	
CEN / TS15209	Dokunurluk Tactility	Yüzey açıklaması beyan edilir Declare surface description	
	SHADE VARIATIONS V1- V5 DESEN,YÜZ FARKLİLİĞİ		Ürüne Özel Bildirilir Product Specific Notifications

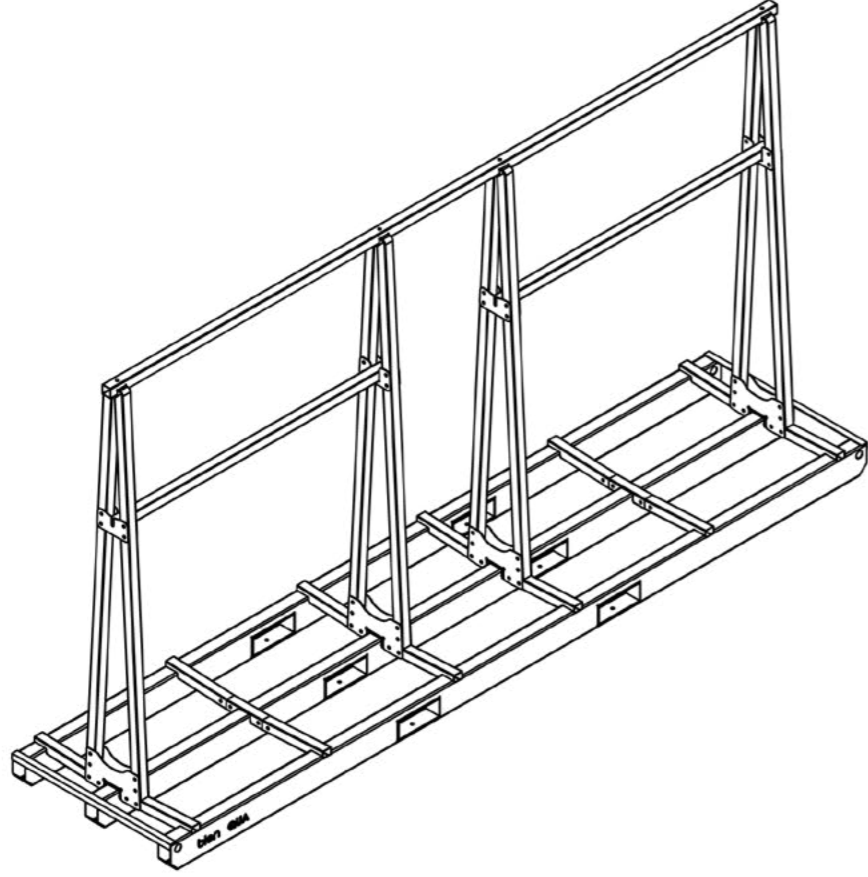

160x320cm A Frame
Boyutlar: 3305mmx755mmx1780mm(h)
Ağırlık: 102kg

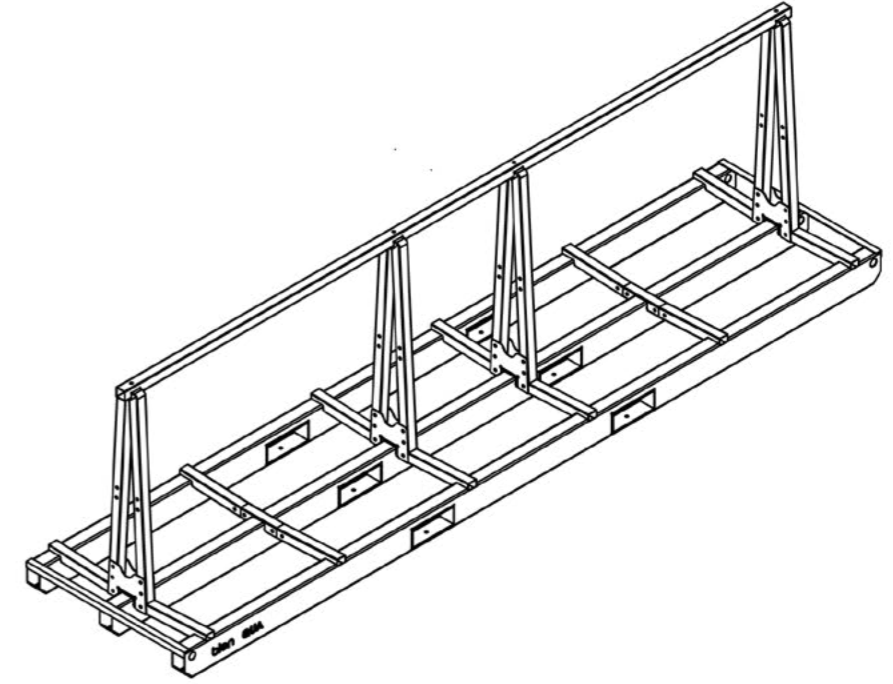

80x320cm A Frame
Boyutlar: 3305mmx755mmx980mm(h)
Ağırlık: 84kg

bien

www.bienexport.com

PAVILION GROUP
İNŞAAT İÇ ve DIŞ TİC. LTD ŞTİ.

Çobançeşme Mh. Kımız Sk. 38 Kat 3 Nissan Plaza 34530 Bahçelievler / İSTANBUL - TÜRKİYE
+90 532 541 7576 / +90 555 140 3333 / +90 555 141 3333
mail: info@bienexport.com
www.bienexport.com

biQslab
MAXTON